

Alice NightOne

Home Sleep Testing

PATIENT INSTRUCTIONS

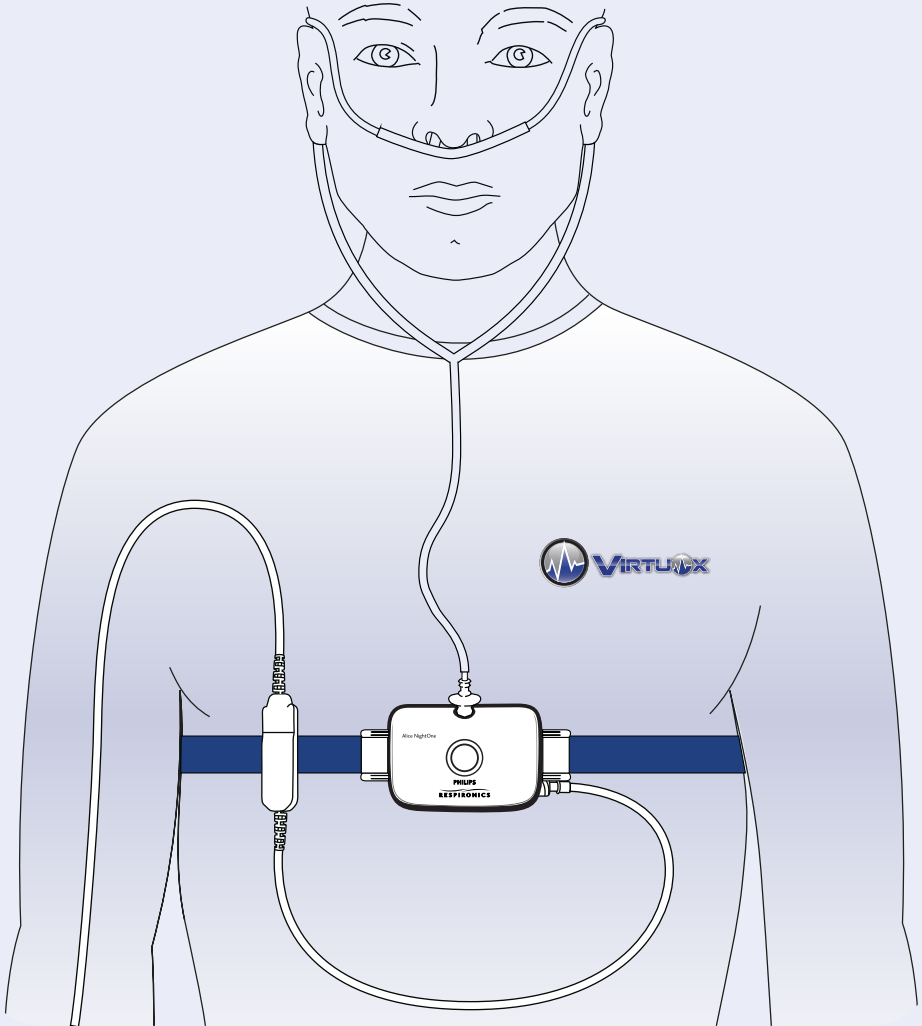

VirtuOx Patient Support
(877) 897-0063
www.virtuox.net



Home Sleep Test Equipment

Please take a moment to familiarize yourself with what is included in the kit:

1. Alice NightOne home sleep test device (with sensors attached and new batteries pre-installed)

2A. Nasal cannula
2B. Gas sampling line (optional for testing on PAP)

3. Finger sensor

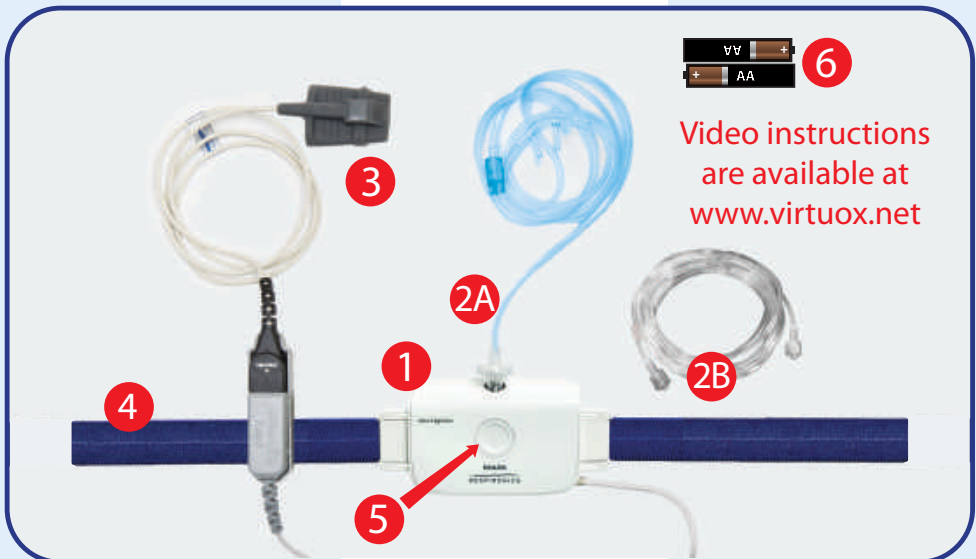

4. Blue elastic effort belt

5. User button (This is not the power button)

6. Extra AA batteries

Top of device

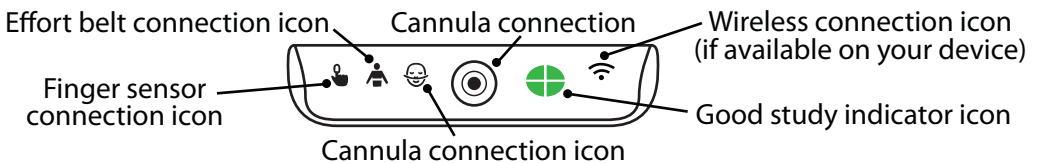

Reminder:

Do not connect the effort belt to the device until you are ready to go to bed and test! Connecting the belt to the device will begin the testing process. You should continue to take any medications, as directed by your prescriber. Please test and return the device promptly!

Home Sleep Test Instructions

Please read these instructions carefully and follow the directions

Step 1: Apply the chest belt

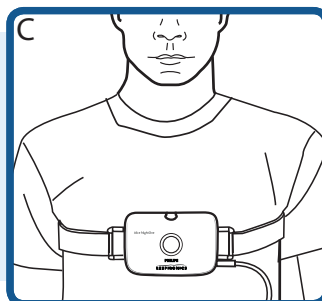
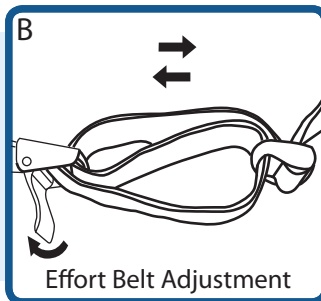
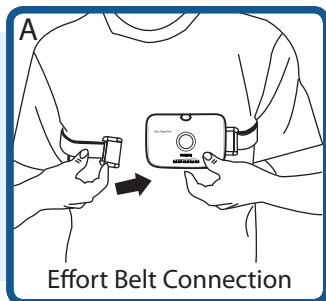

- One side of the belt will come attached to the Alice NightOne device. Wrap the belt around your chest and buckle the other side. Note once you buckle the device securely in place, the device will automatically power on and a solid **green** belt icon will appear on the top of the device. 

-  **The manufacturer recommends that the device be placed at center of your chest, over or under your breasts. If, however, you cannot sleep on your back, you may rotate the belt so the device is at your side.**

Step 2: Apply the finger sensor

Important! Please remove any nail polish or artificial nails from the finger on which the sensor will be applied.

- Slide your finger into the finger sensor. The wire should run along the top of your hand, as shown.
- Your finger should not stick out of the end of the sensor.
- You may change fingers, as needed, for comfort.
- Once the finger sensor is applied, a solid **green** finger icon will appear on the top of the device. 

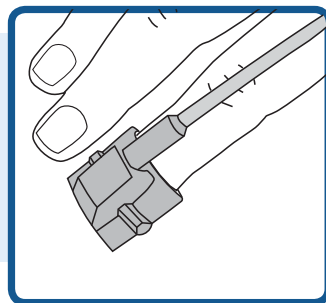

Note: You may use **Band-Aids** or **hypoallergenic tape** to **secure the wire to your finger.**

Step 3A: Apply the nasal cannula

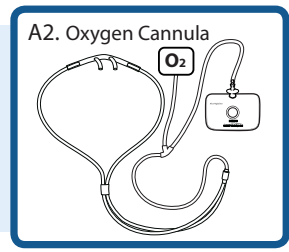
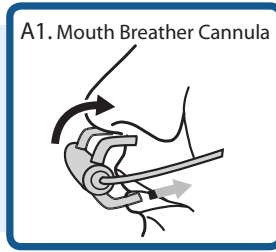
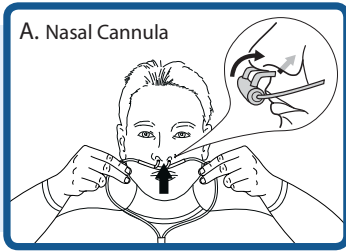

- A. Nasal Cannula - With prongs facing downward and towards your face, insert the nasal cannula with one prong in each nostril, as shown.
- A1. Mouth Breather Cannula (optional) - There will be an additional curved prong towards your mouth.
- A2. Oxygen Cannula (optional) - You will connect one end to your oxygen source.

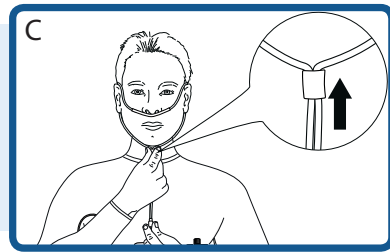
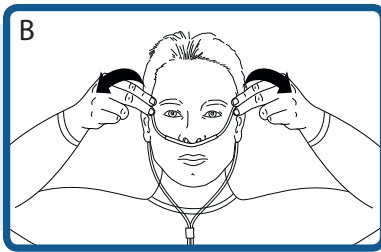

- B. Wrap the cannula behind your ears.
- C. Adjust the slider so that the loop fits securely under your chin. Once the nasal cannula is properly attached, a solid green nasal cannula icon will appear on top of the device. 😊

Note: You may use Band-Aids or hypoallergenic tape to keep the nasal cannula in place.

! If the nasal cannula is not already attached, please attach by twisting the connector onto the device.

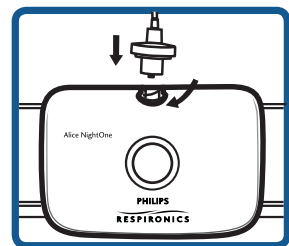

Step 3B: Connecting the gas sampling line to the PAP machine (optional)

- Remove the PAP tubing from the PAP mask.
- Connect the T-piece (provided) to the PAP mask.
- Connect the PAP tubing to the other end of the T-piece.
- Connect the gas sampling line to the side of the T-piece, if not already connected.
- Once the gas sampling line is properly attached, a solid green gas sampling line icon will appear on top of the device. 😊

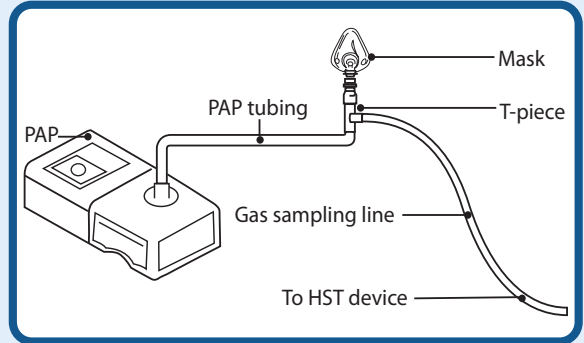

Note: Once all sensors have been attached and applied, the icon lights will turn solid green. Over the next few minutes all of the lights will turn off gradually, one by one.

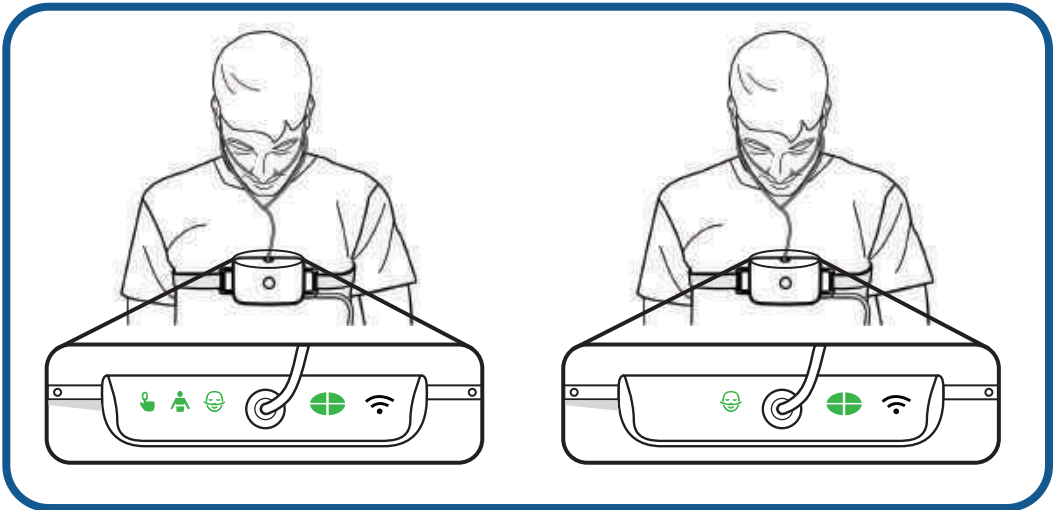

! If any of the lights flash yellow, please check the appropriate sensor for a secure connection to the device and appropriate placement on your body. The light should turn green after a few seconds. Note that the light INSIDE the finger sensor where your finger is placed, should remain RED.

Step 4: Go to sleep

Make sure all indicator lights have turned off.

- Now you are ready to go to sleep.

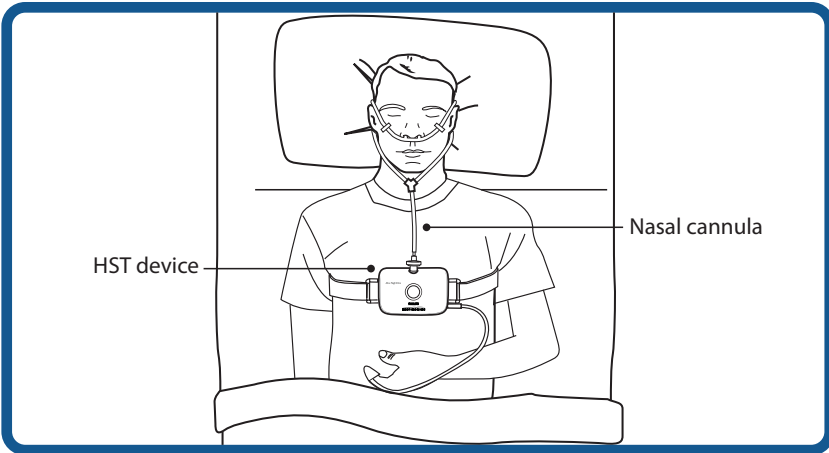
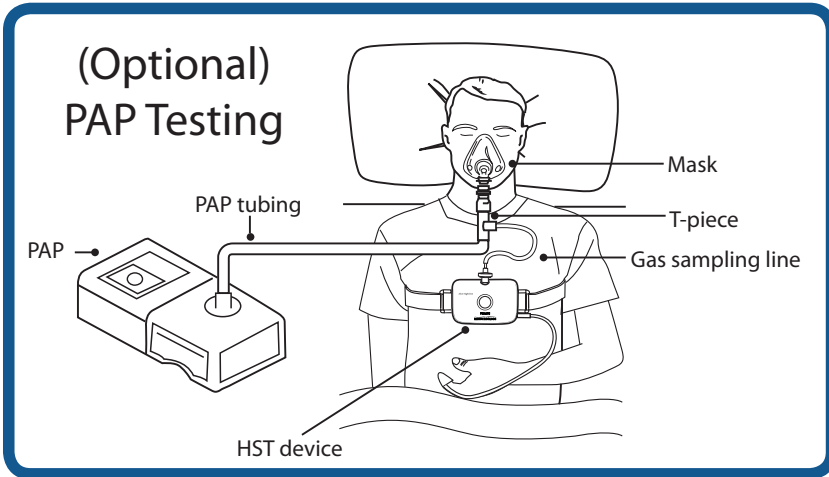

If you need to use the restroom during the night, simply remove the finger sensor. **DO NOT** disconnect the finger sensor from the device or turn the device off. Put the finger sensor back on when you return to bed and continue testing.

Step 5: Morning after testing

- When you wake up the next morning and are finished testing, remove the device and all the sensors. The device will automatically power off once you disconnect the effort belt from the device. Note this could take up to 30 minutes. During this process, the icons will continue flashing yellow.

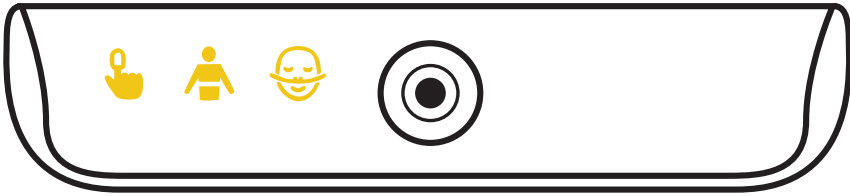

Important! Unless instructed otherwise, you will be testing for two nights.

Step 6: Second night of testing

- Remove the battery covering from the back of the device.
- Remove the used batteries and replace them with the new batteries that were provided.
- Repeat Steps 1-5 for your second night of testing.

! Place the batteries in the correct direction. *See figure A.

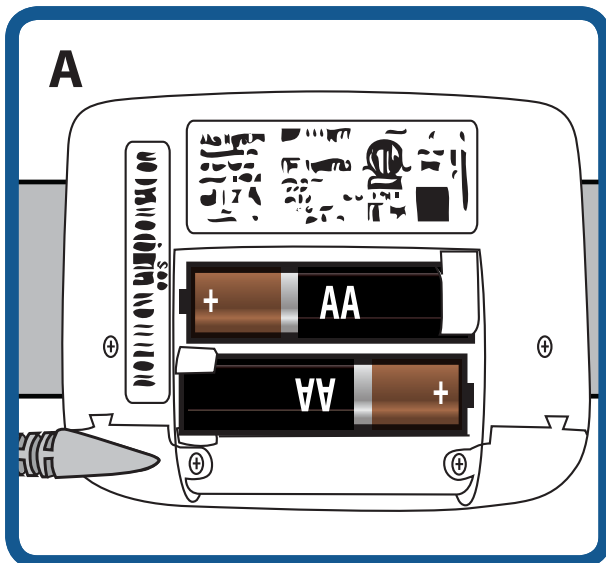



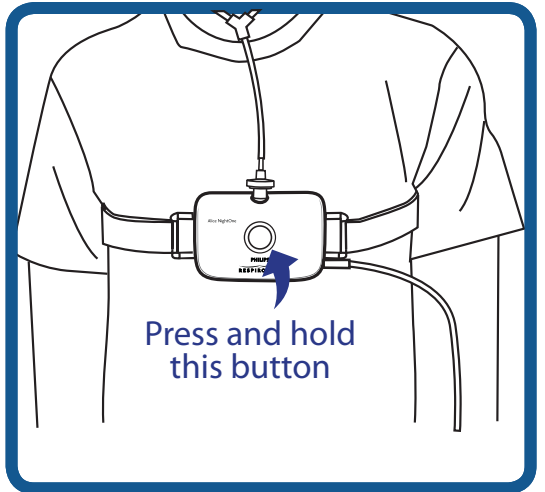

Good Study Indicator

The Good Study Indicator displays how much good data the device has gathered. To view the Good Study Indicator at the end of the study, you must first check that the device has stopped recording. Look inside the finger sensor and if the red light is still on, the device is still in recording mode. To exit the recording mode and end the study, press, and hold the User button until the Good Study Indicator light flashes. Once the device has exited the recording mode, wait at least (1) one minute before briefly pressing and releasing the User button again. The Good Study Indicator lights should appear.



Important! The Good Study Indicator should only be checked at the end of the study. Pressing and holding the User button while a study is in progress will end the study and turn the device off.

Good Study Indicator status

- The device has gathered 25% of the good quality data. 
- The device has gathered 50% of the good quality data. 
- The device has gathered 75% of the good quality data. 
- The device has gathered 100% of the good quality data. 

Step 7: Complete all paperwork

- Complete paperwork and return it with your device.



Step 8: Package the device and return to VirtuOx

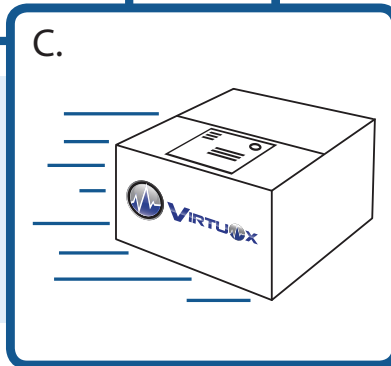
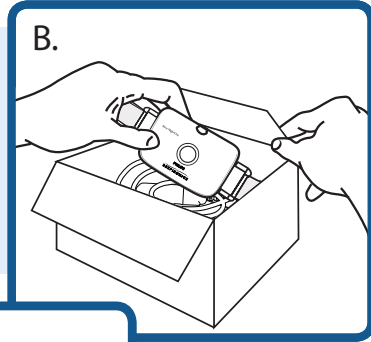
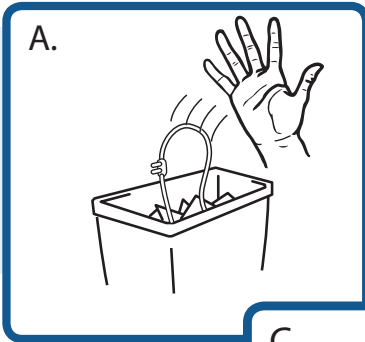

- A. You may unscrew the nasal cannula from the device and discard it. **DO NOT** disconnect any other attachments.
- B. Replace the device, including all other attachments, and the completed paperwork into the provided return package on the next business day.
- C. Use the appropriate shipping carrier on the provided label to return to VirtuOx.

Important! Please send the device back to VirtuOx promptly! This will prevent any delays in getting the test results to your ordering prescriber.

What's Next? Your prescriber should receive the results within two weeks from the day you mail the package back to VirtuOx. Please contact your prescriber to discuss the results and treatment options, if needed.

Frequently Asked Questions

Q Are there video instructions?

A Yes, please visit www.virtuox.net and look under the patient section.

Q I woke up during the night and the device was powered off or the device will not power on at all.

A Please check to confirm the effort belt is still securely connected to the device. If the device still does not power on, please replace the batteries.

Q Should I power off the device if I wake up during the night?

A No, the device will power off automatically once the effort belt is removed.

Q What should I do if one of the green sensor lights do not come on?

A Check the appropriate sensor for a secure connection to the device and the appropriate placement on your body. If the green light still does not come on, please contact VirtuOx Patient Support at (877) 897-0063.

Q What can I do if the finger sensor or nasal cannula will not stay in place?

A You may secure it by using Band-Aids or hypoallergenic tape.

Frequently Asked Questions (cont.)

- Q** What if the cannula is not connected to the device?
- A** You can connect the cannula by twisting it onto the device.

- Q** What if the finger sensor becomes uncomfortable during the night?
- A** You may switch to another finger.

- Q** Do I need to contact you before I begin testing?
- A** No, you do not need to contact us prior to testing.

- Q** When will I get my results?
- A** Please contact your ordering prescriber for your results.

- Q** How many nights do I need to test?
- A** You should test for two nights, unless you were instructed otherwise.

We hope that you find our products and services of the highest quality...

...and have an easy and successful experience with them.





If you have any Home Sleep Test questions please call VirtuOx Patient Support at (877) 897-0063. VirtuOx Patient Support is available to help you 24 hours a day, 7 days a week!



www.virtuox.net

